

Flygt 3069

50 Hz

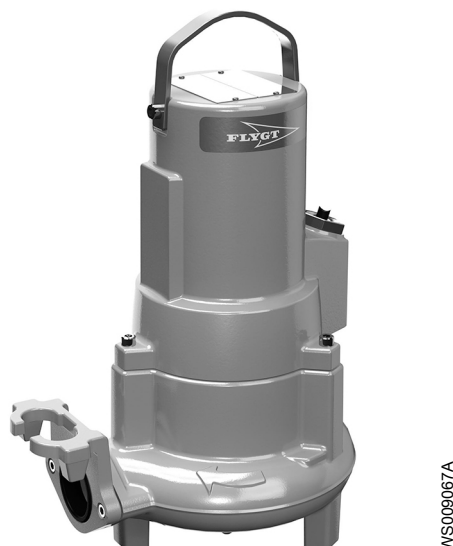

Table of Contents

1 D-pump	2
1.1 Product description.....	2
1.2 Motor rating and performance curves.....	4
2 F-pump	12
2.1 Product description.....	12
2.2 Motor rating and performance curves.....	14
3 M-pump	17
3.1 Product description.....	17
3.2 Motor rating and performance curves.....	19
4 N-pump	22
4.1 Product description.....	22
4.2 Motor rating and performance curves 3069.060.....	25
4.3 Motor rating and performance curves 3069.160.....	28
4.4 Motor rating and performance curves 3069.760.....	32

1 D-pump

1.1 Product description



Usage

A submersible pump, with vortex hydraulic, for liquids containing solids and abrasive media, or light wastewater.

Denomination

Type	Non-explosion proof version	Explosion proof version	Pressure class	Installation types
Gray iron	3069.180	3069.090	<ul style="list-style-type: none"> • LT – Low head • MT – Medium head • HT – High head 	F, H, P, S, X
Cast iron, nodular	3069.180	3069.090	<ul style="list-style-type: none"> • MT – Medium head 	F, S

The pump can be used in the following installations:

- F Free standing semipermanent, wet well arrangement where the pump is placed on a firm surface.
- P Semipermanent, wet well arrangement with the pump installed on two guide bars. The connection to the discharge is automatic.
- S Portable semipermanent, wet well arrangement with hose coupling or flange for connection to the discharge pipeline.
- H Semipermanent, wet well quick connection suspended arrangement, incorporating integral non-return valve.
- X Optional installation, wet or dry well arrangement without predetermined mechanical connection and with drilled flanges. Dry well arrangement requires cooling system or de-rated motor.

Application limits

Feature	Description
Liquid temperature	Maximum 40°C (104°F)

Feature	Description
Liquid temperature, warm water version	Maximum 70°C (158°F)
Depth of immersion	Maximum 20 m (65 ft)
pH of the pumped liquid	5.5 - 14
Liquid density	Maximum 1100 kg/m ³

Motor data

Feature	Description
Motor type	Squirrel-cage induction motor
Frequency	50 Hz
Power supply	1-phase or 3-phase
Starting method	<ul style="list-style-type: none"> • Direct on-line • Star-delta • Soft starter
Number of starts per hour	Maximum 15
Code compliance	IEC 60034-1
Voltage variation	<ul style="list-style-type: none"> • Continuously running: Maximum ±5% • Intermittent running: Maximum ±10%
Voltage imbalance between phases	Maximum 2%
Stator insulation class	F (+155°C)

Cables

Application	Type
Direct-on-line start or Y/D start with two cables	Flygt SUBCAB® - a heavy duty 4 cores motor power cable with two twisted pair screened control cores. Conductor insulation rating of 90°C, which allows for increased current. Superior mechanical strength and high abrasion and tear resistant. Chemical resistant within pH 3-10 and ozone, oil, and flame resistant. Used up to 70°C water temperature. Cables < 10 mm ² with unscreened control cores.
Y/D start	Flygt SUBCAB® - a heavy duty 7 cores motor power cable with two twisted pair screened control cores. Conductor insulation rating of 90°C, which allows for increased current. Superior mechanical strength and high abrasion and tear resistant. Chemical resistant within pH 3-10 and ozone, oil, and flame resistant. Used up to 70°C water temperature. Cables < 7G6 mm ² with unscreened control cores.

Monitoring equipment

Motor	Thermal contacts opening temperature
13-08-4, 13-08-2, 13-10-2	125°C (257°F)
13-10-4	140°C (284°F)

Materials

Table 1: Major parts except mechanical seals

Denomination	Material	ASTM	EN
Major castings	Cast iron, gray	35B	GJL-250

Denomination	Material	ASTM	EN
Pump housing, alternative 1	Cast iron, gray	30B	GJL-200
Pump housing, alternative 2	Cast iron, gray	35B	GJL-250
Impeller, alternative 1	Cast iron, gray	35B	GJL-250
Impeller, alternative 2	Cast iron, gray	30B	GJL-200
Impeller, alternative 3	Cast iron, nodular	-	GJS-700-2
Lifting handle	Stainless steel	AISI 304	1,4301
Shaft	Stainless steel	AISI 431	1.4057+QT800
Screws and nuts	Stainless steel, A2	AISI 304	1.4301, 1.4306, 1.4307, 1.4311
O-rings	Nitrile rubber (NBR) 70° IRH	-	-
Oil, part no 901752	Medical white oil of paraffin type. Fulfills FDA 172.878 (a)	-	-

Table 2: Mechanical seals

Alternative	Inner seal	Outer seal
1	Carbon (CSb)/ Aluminum oxide (Al ₂ O ₃)	Aluminum oxide (Al ₂ O ₃)/ Corrosion resistant cemented carbide (WCCR)
2	Carbon (CSb)/ Aluminum oxide (Al ₂ O ₃)	Corrosion resistant cemented carbide (WCCR)/ Corrosion resistant cemented carbide (WCCR)
3	Corrosion resistant cemented carbide (WCCR)/ Corrosion resistant cemented carbide (WCCR)	Corrosion resistant cemented carbide (WCCR)/ Corrosion resistant cemented carbide (WCCR)

Surface treatment

Priming	Finish
Painted with a primer, see internal standard M0700.00.0002	Navy gray color NCS 5804-B07G. Two-component high-solid top coating, see internal standard M0700.00.0004 for standard painting and M0700.00.0008 for special painting.

Options

- Warm liquid version (non-explosion proof versions)
- Leakage sensor in the stator housing (FLS)
- Surface treatment (Epoxy)
- Zinc anodes
- Other cables

Accessories

Discharge connections, adapters, hose connections, and other mechanical accessories
 Electrical accessories such as pump controller, control panels, starters, monitoring relays, cables

1.2 Motor rating and performance curves

These are examples of motor rating and curves. For more information, please contact your local sales and service representative.

Star-delta starting current is 1/3 of Direct on-line starting current.

LT

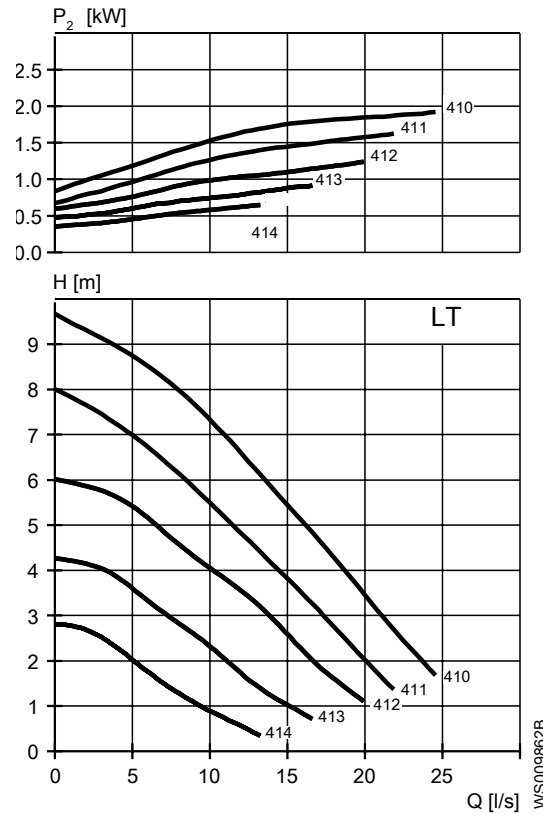

Table 3: 400 V, 50 Hz, 3-phase

Rated power, kW	Rated power, hp	Curve/ Impeller No	Revolutions per minute, rpm	Rated Current, A	Start current, A	Power Factor, cos φ	Installation
2	2.7	410	1360	5.0	20	0.83	F,P,S
2	2.7	411	1360	5.0	20	0.83	F,P,S
2	2.7	412	1360	5.0	20	0.83	F,P,S
2	2.7	413	1360	5.0	20	0.83	F,P,S
2	2.7	414	1360	5.0	20	0.83	F,P,S
1.5	2	412	1370	4.4	16	0.76	F,P,S
1.5	2	413	1370	4.4	16	0.76	F,P,S
1.5	2	414	1370	4.4	16	0.76	F,P,S

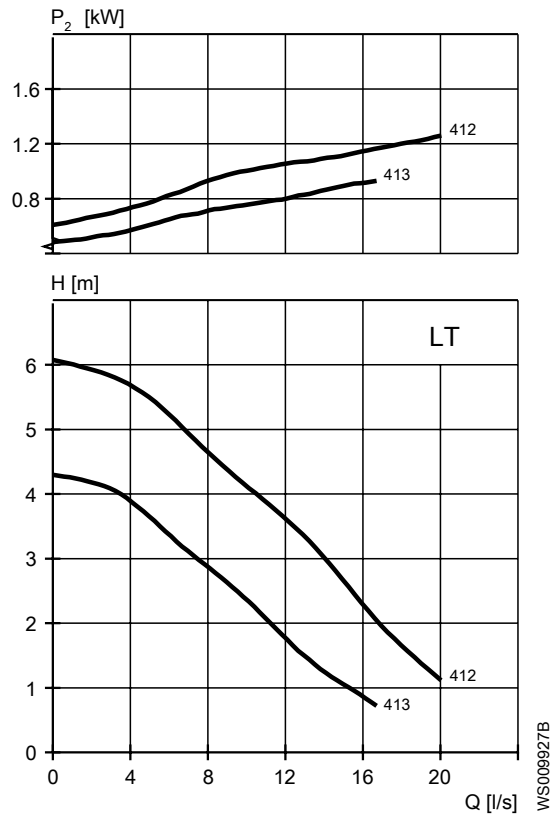

Table 4: 230 V, 50 Hz, 1-phase

Rated power, kW	Rated power, hp	Curve/ Impeller No	Revolutions per minute, rpm	Rated Current, A	Start current, A	Power Factor, cos ϕ	Installation
1.3	1.7	412	1400	8.4	28	1	F,P,S
1.3	1.7	413	1400	8.4	28	1	F,P,S

MT D-impeller, standard

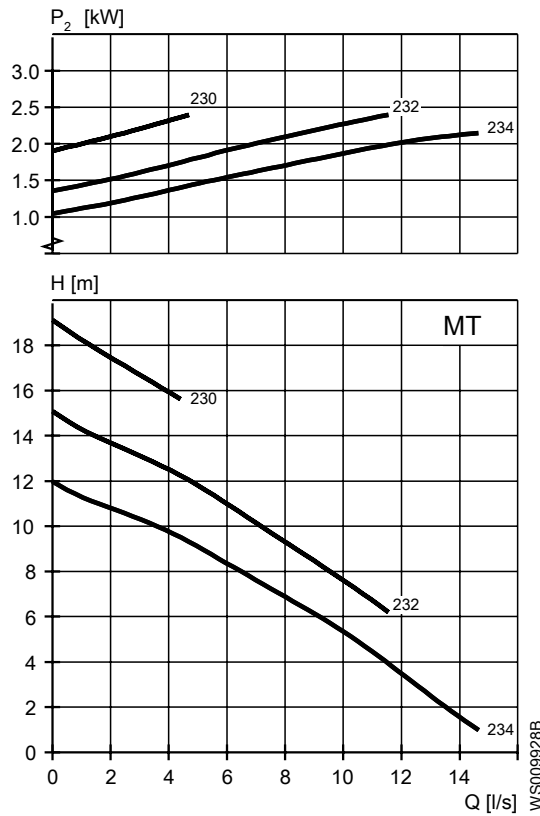
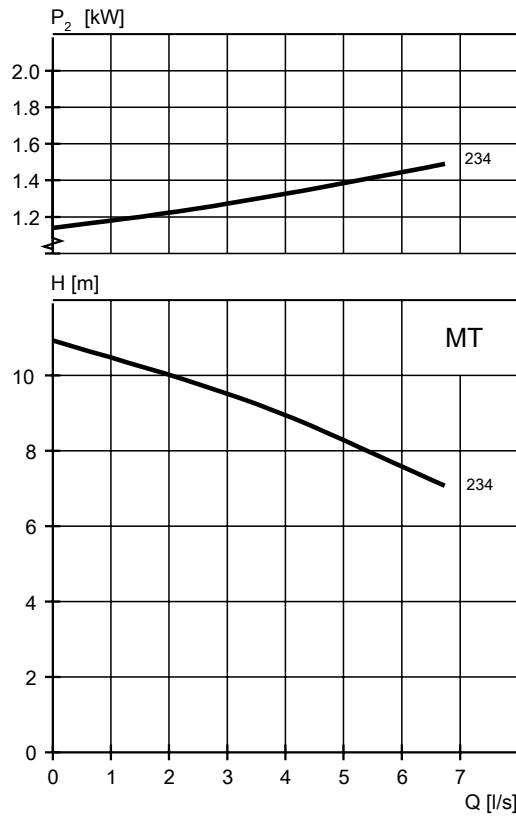

Table 5: 400 V, 50 Hz, 3-phase

Rated power, kW	Rated power, hp	Curve/ Impeller No	Revolutions per minute, rpm	Rated Current, A	Start current, A	Power Factor, cos φ	Installation
2.4	3.2	230	2775	5.1	27	0.86	F,P,S
2.4	3.2	232	2775	5.1	27	0.86	F,P,S
2.4	3.2	234	2775	5.1	27	0.86	F,P,S



WS010325A

Table 6: 230 V, 50 Hz, 1-phase

Rated power, kW	Rated power, hp	Curve/ Impeller No	Revolutions per minute, rpm	Rated Current, A	Start current, A	Power Factor, cos ϕ	Installation
1.5	2.0	234	2730	8.9	28	0.99	F,P,S

MT D-impeller, abrasive

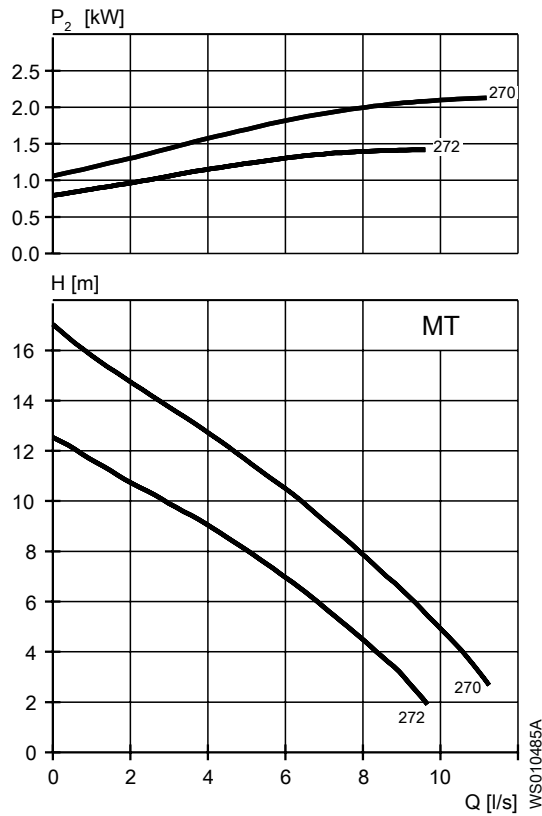

Table 7: 400 V, 50 Hz, 3-phase

Rated power, kW	Rated power, hp	Curve/ Impeller No	Revolutions per minute, rpm	Rated Current, A	Start current, A	Power Factor, cos ϕ	Installation
2.4	3.2	270	2775	5.1	27	0.86	F,P,S
2.4	3.2	272	2775	5.1	27	0.86	F,P,S
1.7	2.3	272	2695	3.8	17	0.87	F,P,S

HT

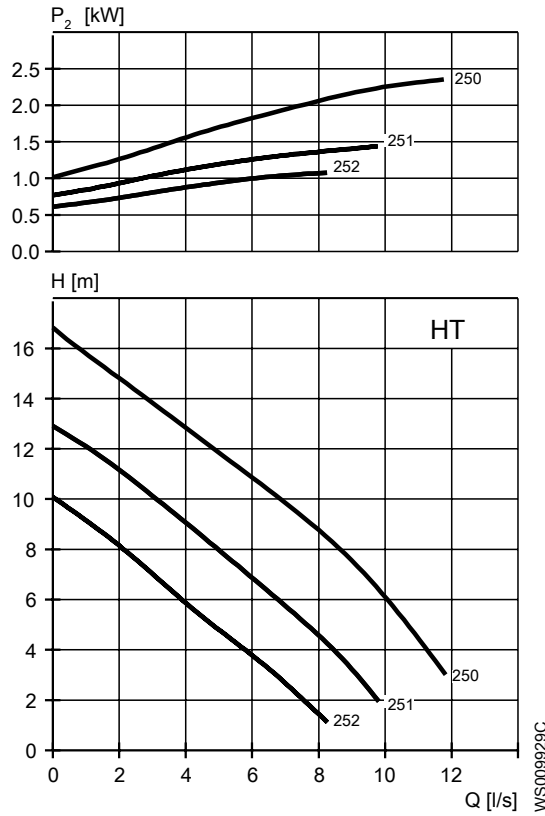

Table 8: 400 V, 50 Hz, 3-phase

Rated power, kW	Rated power, hp	Curve/ Impeller No	Revolutions per minute, rpm	Rated Current, A	Start current, A	Power Factor, cos ϕ	Installation
2.4	3.2	250	2775	5.1	27	0.86	F,H,P,S
2.4	3.2	251	2775	5.1	27	0.86	F,H,P,S
2.4	3.2	252	2775	5.1	27	0.86	F,H,P,S
1.7	2.3	251	2695	3.8	17	0.87	F,H,P,S
1.7	2.3	252	2695	3.8	17	0.87	F,H,P,S

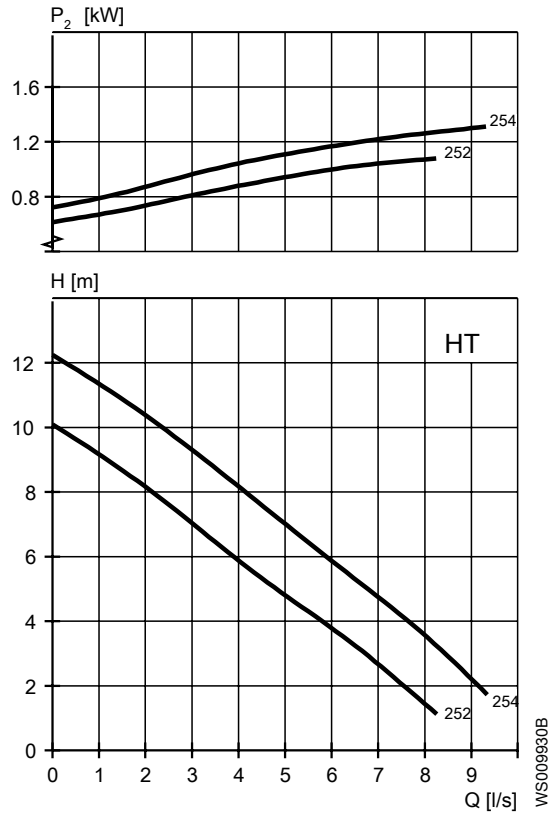
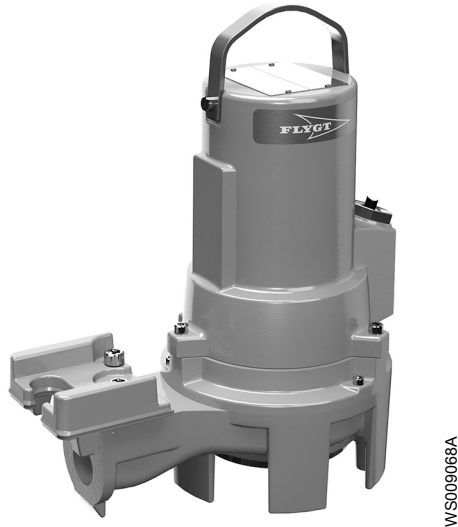

Table 9: 230 V, 50 Hz, 1-phase

Rated power, kW	Rated power, hp	Curve/ Impeller No	Revolutions per minute, rpm	Rated Current, A	Start current, A	Power Factor, cos φ	Installation
1.5	2	252	2730	8.9	28	0.99	F,H,P,S
1.5	2	254	2730	8.9	28	0.99	F,H,P,S

2 F-pump

2.1 Product description



WS009068A

Usage

A submersible pump for light liquid manure, or contaminated sewage and sludge. The impeller is S-shaped and fitted with a cutting device.

Denomination

Type	Non-explosion proof version	Explosion proof version	Pressure class	Installation types
Chopper Hard-Iron™	3069.180	3069.090	LT – Low head	P, S

The pump can be used in the following installations:

- P Semipermanent, wet well arrangement with the pump installed on two guide bars. The connection to the discharge is automatic.
- S Portable semipermanent, wet well arrangement with hose coupling or flange for connection to the discharge pipeline.

Application limits

Feature	Description
Liquid temperature	Maximum 40°C (104°F)
Liquid temperature, warm water version	Maximum 70°C (158°F)
Depth of immersion	Maximum 20 m (65 ft)
pH of the pumped liquid	5.5 - 14
Liquid density	Maximum 1100 kg/m ³

Motor data

Feature	Description
Motor type	Squirrel-cage induction motor
Frequency	50 Hz

Feature	Description
Power supply	3-phase
Starting method	<ul style="list-style-type: none"> • Direct on-line • Star-delta • Soft starter
Number of starts per hour	Maximum 15
Code compliance	IEC 60034-1
Voltage variation	<ul style="list-style-type: none"> • Continuously running: Maximum $\pm 5\%$ • Intermittent running: Maximum $\pm 10\%$
Voltage imbalance between phases	Maximum 2%
Stator insulation class	F (+155°C)

Cables

Application	Type
Direct-on-line start or Y/D start with two cables	Flygt SUBCAB® - a heavy duty 4 cores motor power cable with two twisted pair screened control cores. Conductor insulation rating of 90°C, which allows for increased current. Superior mechanical strength and high abrasion and tear resistant. Chemical resistant within pH 3-10 and ozone, oil, and flame resistant. Used up to 70°C water temperature. Cables < 10 mm ² with unscreened control cores.
Y/D start	Flygt SUBCAB® - a heavy duty 7 cores motor power cable with two twisted pair screened control cores. Conductor insulation rating of 90°C, which allows for increased current. Superior mechanical strength and high abrasion and tear resistant. Chemical resistant within pH 3-10 and ozone, oil, and flame resistant. Used up to 70°C water temperature. Cables < 7G6 mm ² with unscreened control cores.

Monitoring equipment

Motor	Thermal contacts opening temperature
13-08-2, 13-10-2	125°C (257°F)

Materials

Table 10: Major parts except mechanical seals

Denomination	Material	ASTM	EN
Major castings	Cast iron, gray	30B	GJL-200
Pump housing	Cast iron, gray	35B	GJL-250
Impeller	Hard-Iron™	A 532 IIIA	GJN-HB555(XCR23)
Suction cover	Cast iron, gray	30B	GJL-200
Lifting handle	Stainless steel	AISI 304	1,4301
Shaft	Stainless steel	AISI 431	1.4057+QT800
Screws and nuts	Stainless steel, A2	AISI 304	1.4301, 1.4306, 1.4307, 1.4311
O-rings	Nitrile rubber (NBR) 70° IRH	-	-
Oil, part no 901752	Medical white oil of paraffin type. Fulfills FDA 172.878 (a)	-	-

Table 11: Mechanical seals

Alternative	Inner seal	Outer seal
1	Carbon (CSb)/ Aluminum oxide (Al ₂ O ₃)	Aluminum oxide (Al ₂ O ₃)/ Corrosion resistant cemented carbide (WCCR)
2	Carbon (CSb)/ Aluminum oxide (Al ₂ O ₃)	Corrosion resistant cemented carbide (WCCR)/ Corrosion resistant cemented carbide (WCCR)
3	Corrosion resistant cemented carbide (WCCR)/ Corrosion resistant cemented carbide (WCCR)	Corrosion resistant cemented carbide (WCCR)/ Corrosion resistant cemented carbide (WCCR)

Surface treatment

Priming	Finish
Painted with a primer, see internal standard M0700.00.0002	Navy gray color NCS 5804-B07G. Two-component high-solid top coating, see internal standard M0700.00.0004 for standard painting and M0700.00.0008 for special painting.

Options

- Warm liquid version (non-explosion proof versions)
- Leakage sensor in the stator housing (FLS)
- Surface treatment (Epoxy)
- Zinc anodes
- Other cables

Accessories

Discharge connections, adapters, hose connections, and other mechanical accessories
Electrical accessories such as pump controller, control panels, starters, monitoring relays, cables

2.2 Motor rating and performance curves

These are examples of motor rating and curves. For more information, please contact your local sales and service representative.

Star-delta starting current is 1/3 of Direct on-line starting current.

LT

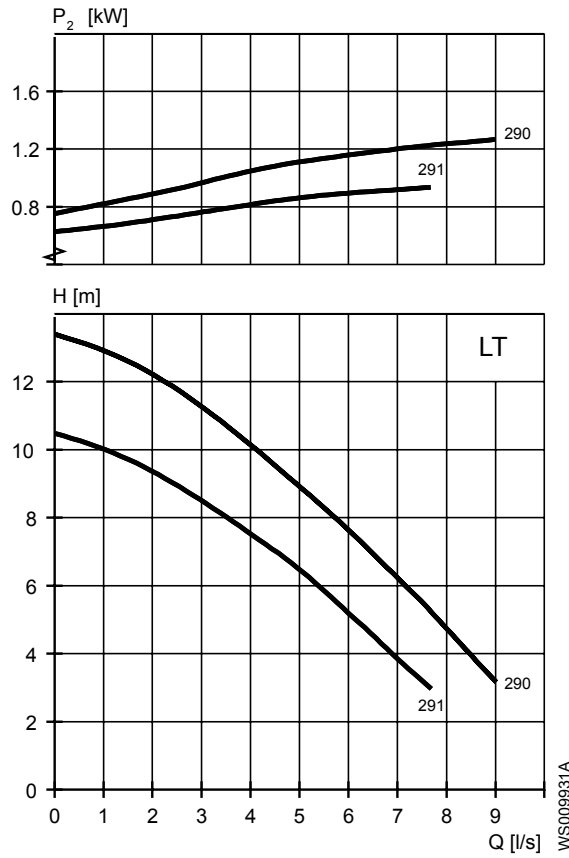

Table 12: 400 V, 50 Hz, 3-phase

Rated power, kW	Rated power, hp	Curve/ Impeller No	Revolutions per minute, rpm	Rated Current, A	Start current, A	Power Factor, cos ϕ	Installation
2.4	3.2	290	2775	5.1	27	0.86	F,P,S
2.4	3.2	291	2775	5.1	27	0.86	F,P,S
1.7	2.3	290	2695	3.8	17	0.87	F,P,S
1.7	2.3	291	2695	3.8	17	0.87	F,P,S

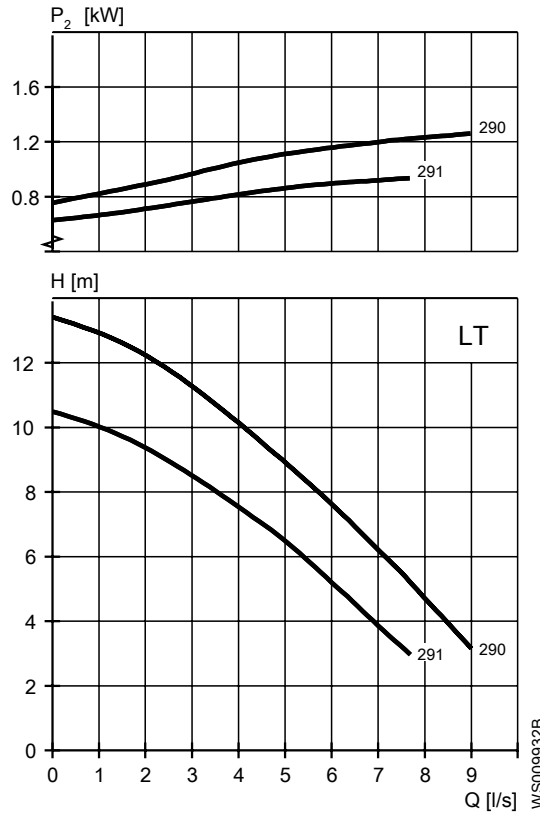

Table 13: 230 V, 50 Hz, 1-phase

Rated power, kW	Rated power, hp	Curve/ Impeller No	Revolutions per minute, rpm	Rated Current, A	Start current, A	Power Factor, cos φ	Installation
1.5	2	290	2730	8.9	28	0.99	F,P,S
1.5	2	291	2730	8.9	28	0.99	F,P,S

3 M-pump

3.1 Product description



Usage

A submersible pump for wastewater containing solids that need to be macerated. The impeller is equipped with a grinder device.

Denomination

Type	Non-explosion proof version	Explosion proof version	Pressure class	Installation types
Gray iron Grinder	3069.170	3069.890	HT – High head	F, H, P, X

The pump can be used in the following installations:

- F Free standing semipermanent, wet well arrangement where the pump is placed on a firm surface.
- H Semipermanent, wet well quick connection suspended arrangement, incorporating integral non-return valve.
- P Semipermanent, wet well arrangement with the pump installed on two guide bars. The connection to the discharge is automatic.
- X Optional installation, wet or dry well arrangement without predetermined mechanical connection and with drilled flanges. Dry well arrangement requires cooling system or de-rated motor.

Application limits

Feature	Description
Liquid temperature	Maximum 40°C (104°F)
Liquid temperature, warm water version	Maximum 70°C (158°F)
Depth of immersion	Maximum 20 m (65 ft)
pH of the pumped liquid	5.5 - 14
Liquid density	Maximum 1100 kg/m ³

Motor data

Feature	Description
Motor type	Squirrel-cage induction motor
Frequency	50 Hz
Power supply	1-phase or 3-phase
Starting method	<ul style="list-style-type: none"> • Direct on-line • Star-delta • Soft starter
Number of starts per hour	Maximum 15
Code compliance	IEC 60034-1
Voltage variation	<ul style="list-style-type: none"> • Continuously running: Maximum $\pm 5\%$ • Intermittent running: Maximum $\pm 10\%$
Voltage imbalance between phases	Maximum 2%
Stator insulation class	F (+155°C)

Cables

Application	Type
Direct-on-line start or Y/D start with two cables	Flygt SUBCAB® - a heavy duty 4 cores motor power cable with two twisted pair screened control cores. Conductor insulation rating of 90°C, which allows for increased current. Superior mechanical strength and high abrasion and tear resistant. Chemical resistant within pH 3-10 and ozone, oil, and flame resistant. Used up to 70°C water temperature. Cables < 10 mm ² with unscreened control cores.
Y/D start	Flygt SUBCAB® - a heavy duty 7 cores motor power cable with two twisted pair screened control cores. Conductor insulation rating of 90°C, which allows for increased current. Superior mechanical strength and high abrasion and tear resistant. Chemical resistant within pH 3-10 and ozone, oil, and flame resistant. Used up to 70°C water temperature. Cables < 7G6 mm ² with unscreened control cores.

Monitoring equipment

Motor	Thermal contacts opening temperature
13-08-2, 13-10-2	125°C (257°F)

Materials

Table 14: Major parts except mechanical seals

Denomination	Material	ASTM	EN
Major castings, alternative 1	Cast iron, gray	30B	GJL-200
Major castings, alternative 2	Cast iron, gray	35B	GJL-250
Pump housing	Cast iron, gray	30B	GJL-200
Impeller	Cast iron, gray	30B	GJL-200
Suction cover	Cast iron, gray	30B	GJL-200
Cutter wheel	Stainless steel, martensitic	AISI 440C	1.4122
Cutter plate	Stainless steel, martensitic	AISI 440C	1.4122

Denomination	Material	ASTM	EN
Lifting handle	Stainless steel	AISI 304	1,4301
Shaft	Stainless steel	AISI 431	1.4057+QT800
Screws and nuts	Stainless steel, A2	AISI 304	1.4301, 1.4306, 1.4307, 1.4311
O-rings	Nitrile rubber (NBR) 70° IRH	-	-
Oil, part no 901752	Medical white oil of paraffin type. Fulfills FDA 172.878 (a)	-	-

Table 15: Mechanical seals

Alternative	Inner seal	Outer seal
1	Carbon (CSb)/ Aluminum oxide (Al ₂ O ₃)	Aluminum oxide (Al ₂ O ₃)/ Corrosion resistant cemented carbide (WCCR)
2	Carbon (CSb)/ Aluminum oxide (Al ₂ O ₃)	Corrosion resistant cemented carbide (WCCR)/ Corrosion resistant cemented carbide (WCCR)

Surface treatment

Priming	Finish
Painted with a primer, see internal standard M0700.00.0002	Navy gray color NCS 5804-B07G. Two-component high-solid top coating, see internal standard M0700.00.0004 for standard painting and M0700.00.0008 for special painting.

Options

- Leakage sensor in the stator housing (FLS)
- Surface treatment (Epoxy)
- Zinc anodes
- Other cables

Accessories

Discharge connections, adapters, hose connections, and other mechanical accessories
 Electrical accessories such as pump controller, control panels, starters, monitoring relays, cables

3.2 Motor rating and performance curves

These are examples of motor rating and curves. For more information, please contact your local sales and service representative.

Star-delta starting current is 1/3 of Direct on-line starting current.

HT

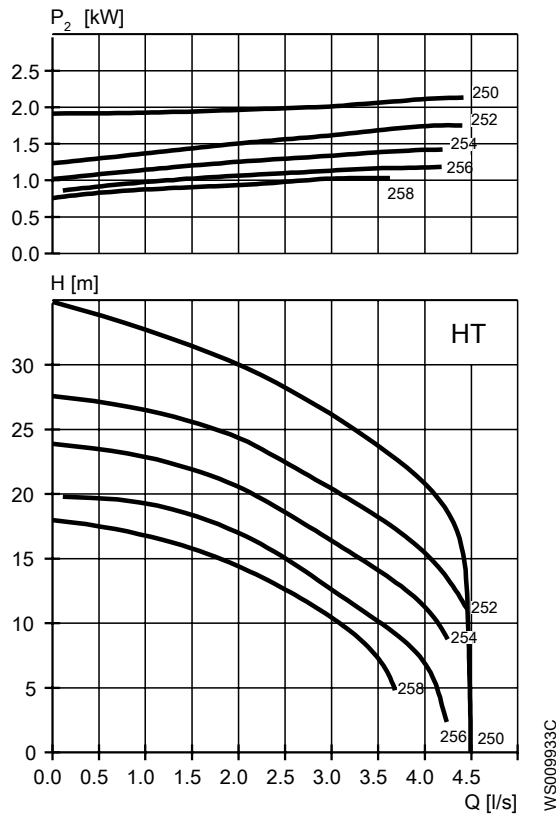

Table 16: 400 V, 50 Hz, 3-phase

Rated power, kW	Rated power, hp	Curve/ Impeller No	Revolutions per minute, rpm	Rated Current, A	Start current, A	Power Factor, cos ϕ	Installation
1.7	2.3	254	2700	3.8	17	0.87	F,H,P,S
1.7	2.3	256	2700	3.8	17	0.87	F,H,P,S
1.7	2.3	258	2700	3.8	17	0.87	F,H,P,S
2.4	3.2	250	2780	5.1	27	0.86	F,H,P,S
2.4	3.2	252	2780	5.1	27	0.86	F,H,P,S
2.4	3.2	254	2780	5.1	27	0.86	F,H,P,S
2.4	3.2	256	2780	5.1	27	0.86	F,H,P,S
2.4	3.2	258	2780	5.1	27	0.86	F,H,P,S

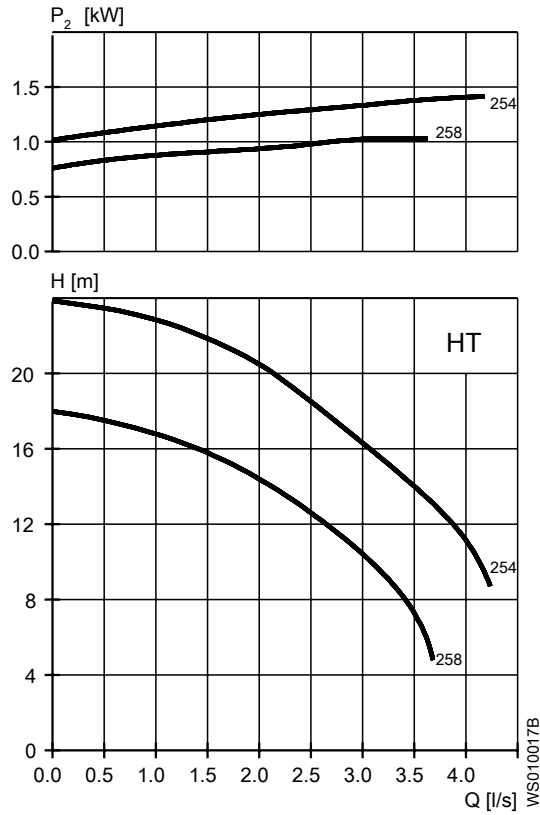

Table 17: 230 V, 50 Hz, 1-phase

Rated power, kW	Rated power, hp	Curve/ Impeller No	Revolutions per minute, rpm	Rated Current, A	Start current, A	Power Factor, $\cos \varphi$	Installation
1.5	2	254	2730	8.9	28	0.99	F,H,P,S
1.5	2	258	2730	8.9	28	0.99	F,H,P,S

4 N-pump

4.1 Product description



W5009070A

Usage

A submersible pump for efficient pumping of clean water, surface water, and wastewater containing solids or long-fibered material. The pump is designed for sustained high efficiency. For abrasive media, Hard-Iron™ is required. Stainless steel N-impeller is available as an option.

Denomination

Type	Non-explosion proof version	Explosion proof version	Pressure class	Installation types
Gray iron	3069.160	3069.190	MT – Medium head SH – Super head	F, H, P, S, X
Hard-Iron™	3069.060	3069.070	MT – Medium head SH – Super head	F, H, P, S, X
Stainless steel	3069.760	3069.770	MT – Medium head SH – Super head	F, H, P, S, X

The pump can be used in the following installations:

- F Free standing semipermanent, wet well arrangement where the pump is placed on a firm surface.
- P Semipermanent, wet well arrangement with the pump installed on two guide bars. The connection to the discharge is automatic.
- S Portable semipermanent, wet well arrangement with hose coupling or flange for connection to the discharge pipeline.
- H Semipermanent, wet well quick connection suspended arrangement, incorporating integral non-return valve.
- X Optional installation, wet or dry well arrangement without predetermined mechanical connection and with drilled flanges. Dry well arrangement requires cooling system or de-rated motor.

Application limits

Feature	Description
Liquid temperature	Maximum 40°C (104°F)
Liquid temperature, warm water version	Maximum 70°C (158°F)
Depth of immersion	Maximum 20 m (65 ft)
pH of the pumped liquid	5.5 - 14
Liquid density	Maximum 1100 kg/m ³

Motor data

Feature	Description
Motor type	Squirrel-cage induction motor
Frequency	50 Hz
Power supply	1-phase or 3-phase
Starting method	<ul style="list-style-type: none"> • Direct on-line • Star-delta • Soft starter
Number of starts per hour	Maximum 15
Code compliance	IEC 60034-1
Voltage variation	<ul style="list-style-type: none"> • Continuously running: Maximum ±5% • Intermittent running: Maximum ±10%
Voltage imbalance between phases	Maximum 2%
Stator insulation class	F (+155°C)

Cables

Application	Type
Direct-on-line start or Y/D start with two cables	Flygt SUBCAB® - a heavy duty 4 cores motor power cable with two twisted pair screened control cores. Conductor insulation rating of 90°C, which allows for increased current. Superior mechanical strength and high abrasion and tear resistant. Chemical resistant within pH 3-10 and ozone, oil, and flame resistant. Used up to 70°C water temperature. Cables < 10 mm ² with unscreened control cores.
Y/D start	Flygt SUBCAB® - a heavy duty 7 cores motor power cable with two twisted pair screened control cores. Conductor insulation rating of 90°C, which allows for increased current. Superior mechanical strength and high abrasion and tear resistant. Chemical resistant within pH 3-10 and ozone, oil, and flame resistant. Used up to 70°C water temperature. Cables < 7G6 mm ² with unscreened control cores.

Monitoring equipment

Motor	Thermal contacts opening temperature
13-08-4, 13-08-2, 13-10-2	125°C (257°F)
13-10-4	140°C (284°F)

Materials

Table 18: Major parts except mechanical seals

Denomination	Material	ASTM	EN
Major castings	Cast iron, gray	35B	GJL-250
Pump housing	Cast iron, gray	35B	GJL-250
Impeller, alternative 1	Cast iron, gray	35B	GJL-250
Impeller, alternative 2	Cast iron, Hard-Iron™	A 532 IIIA	GJN-HB555(XCR23)
Impeller, alternative 3	Stainless steel, Duplex	CD-4MCuN	10283:2010 -1.4474
Insert ring, alternative 1	Cast iron, gray	35B	GJL-250
Insert ring, alternative 2	Cast iron, Hard-Iron™	A 532 IIIA	GJN-HB555(XCR23)
Lifting handle	Stainless steel	AISI 316L	1.4404, 1.4432, ...
Shaft	Stainless steel	AISI 431	1.4057+QT800
Screws and nuts	Stainless steel, A4	AISI 316L, 316, 316Ti	1.4401, 1.4404, ...
O-rings, alternative 1	Nitrile rubber (NBR) 70° IRH	-	-
O-rings, alternative 2	Fluorinated rubber (FPM) 70° IRH	-	-
Oil, part no 901752	Medical white oil of paraffin type. Fulfills FDA 172.878 (a)	-	-

Table 19: Mechanical seals

Alternative	Inner seal	Outer seal
1	Carbon (CSb)/ Aluminum oxide (Al ₂ O ₃)	Corrosion resistant cemented carbide (WCCR)/ Corrosion resistant cemented carbide (WCCR)
2	Carbon (CSb)/ Aluminum oxide (Al ₂ O ₃)	Silicon carbide (RSiC)/ Silicon carbide (RSiC)
3	Corrosion resistant cemented carbide (WCCR)/ Corrosion resistant cemented carbide (WCCR)	Corrosion resistant cemented carbide (WCCR)/ Corrosion resistant cemented carbide (WCCR)

Surface treatment

Priming	Finish
Painted with a primer, see internal standard M0700.00.0002	Navy gray color NCS 5804-B07G. Two-component high-solid top coating, see internal standard M0700.00.0004 for standard painting and M0700.00.0008 for special painting.

Options

- Warm liquid version (non-explosion proof versions)
- Leakage sensor in the stator housing (FLS)
- Surface treatment (Epoxy)
- Zinc anodes
- Other cables

Accessories

Discharge connections, adapters, hose connections, and other mechanical accessories
 Electrical accessories such as pump controller, control panels, starters, monitoring relays, cables

4.2 Motor rating and performance curves 3069.060

These are examples of motor rating and curves. For more information, please contact your local sales and service representative.

Star-delta starting current is 1/3 of Direct on-line starting current.

MT

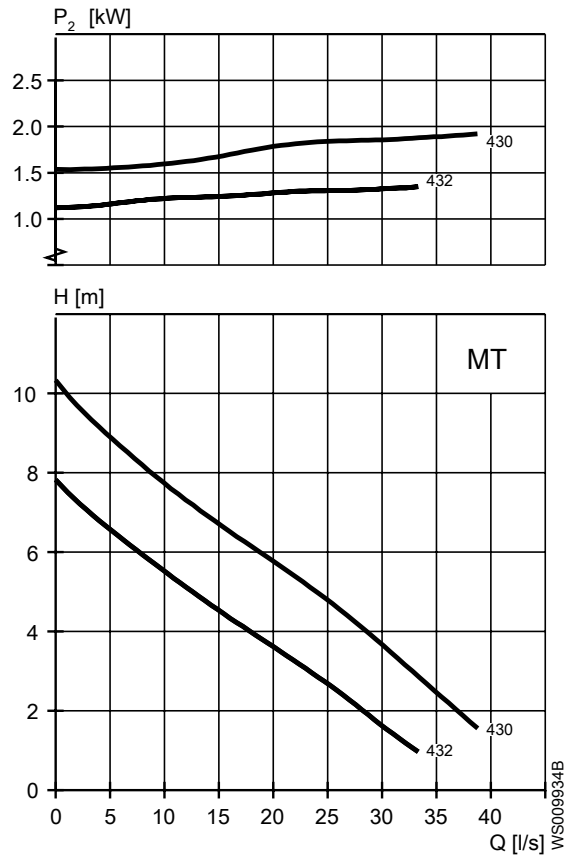

Table 20: 400 V, 50 Hz, 3-phase

Rated power, kW	Rated power, hp	Curve/ Impeller No	Revolutions per minute, rpm	Rated Current, A	Start current, A	Power Factor, $\cos \varphi$	Installation
1.5	2	432	1370	4.4	16	0.76	F,P,S
2	2.7	430	1360	5.0	20	0.83	F,P,S
2	2.7	432	1360	5.0	20	0.83	F,P,S

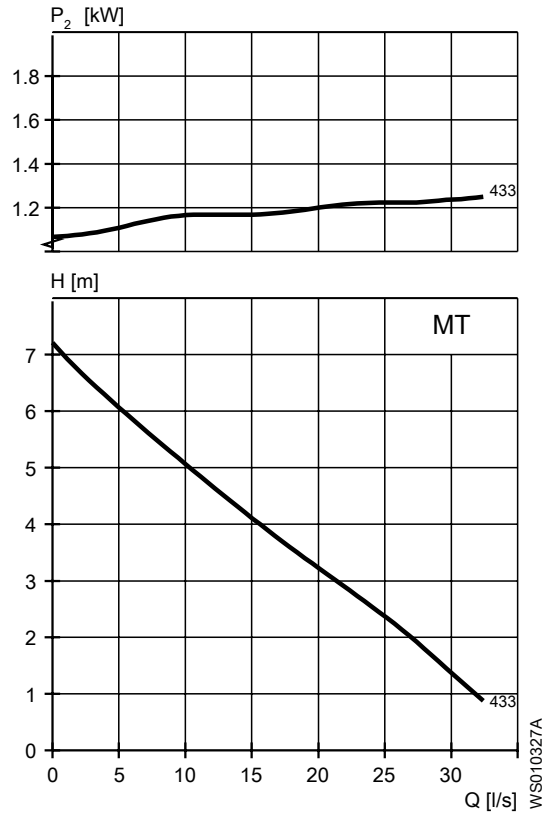

Table 21: 230 V, 50 Hz, 1-phase

Rated power, kW	Rated power, hp	Curve/ Impeller No	Revolutions per minute, rpm	Rated Current, A	Start current, A	Power Factor, cos φ	Installation
1.3	1.7	433	1400	8.4	28	1	F,P,S

SH

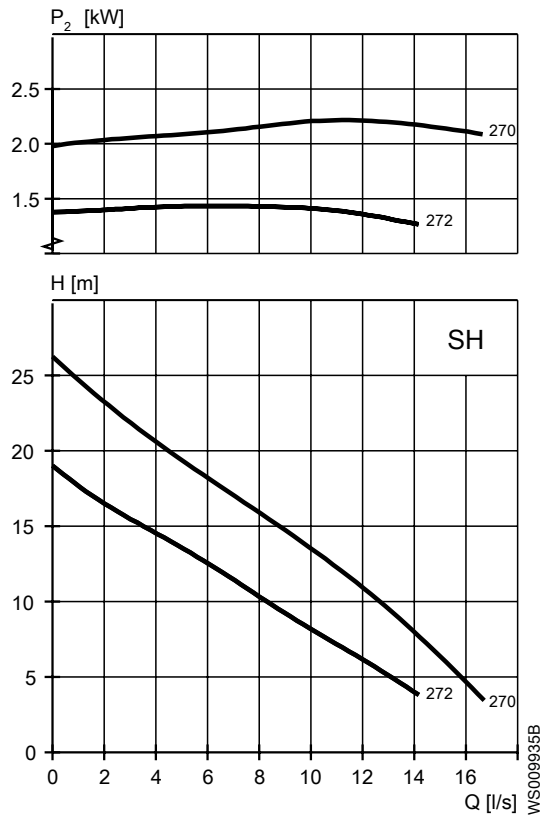

Table 22: 400 V, 50 Hz, 3-phase

Rated power, kW	Rated power, hp	Curve/ Impeller No	Revolutions per minute, rpm	Rated Current, A	Start current, A	Power Factor, cos φ	Installation
2.4	3.2	270	2775	5.1	27	0.86	F,H,P,S
2.4	3.2	272	2775	5.1	27	0.86	F,H,P,S
1.7	2.3	272	2695	3.8	17	0.87	F,H,P,S

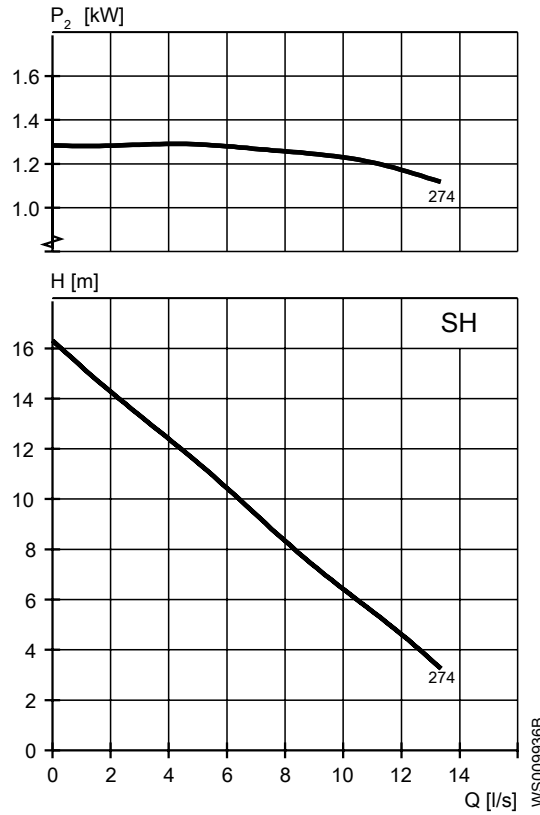

Table 23: 230 V, 50 Hz, 1-phase

Rated power, kW	Rated power, hp	Curve/ Impeller No	Revolutions per minute, rpm	Rated Current, A	Start current, A	Power Factor, cos φ	Installation
1.5	2	274	2730	8.9	28	0.99	F,H,P,S

4.3 Motor rating and performance curves 3069.160

These are examples of motor rating and curves. For more information, please contact your local sales and service representative.

Star-delta starting current is 1/3 of Direct on-line starting current.

MT

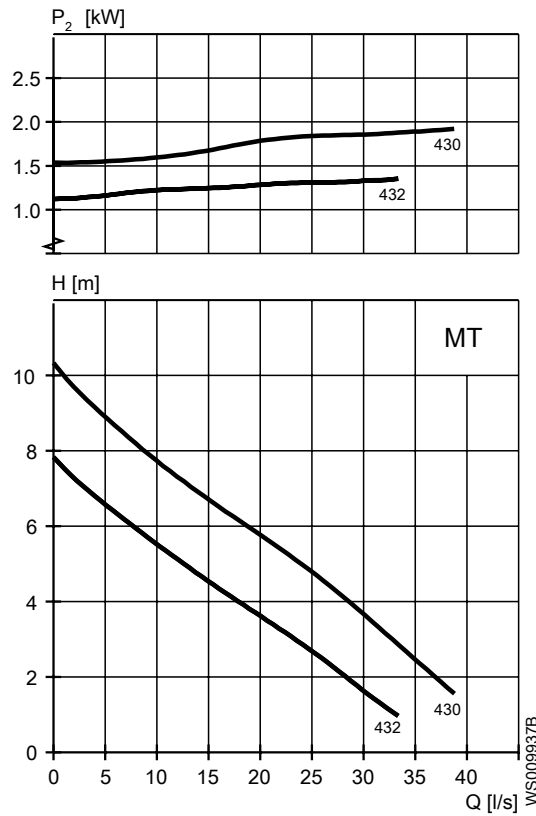

Table 24: 400 V, 50 Hz, 3-phase

Rated power, kW	Rated power, hp	Curve/ Impeller No	Revolutions per minute, rpm	Rated Current, A	Start current, A	Power Factor, $\cos \varphi$	Installation
2	2.7	430	1360	5.0	20	0.83	F,P,S
2	2.7	432	1360	5.0	20	0.83	F,P,S
1.5	2	432	1370	4.4	16	0.76	F,P,S

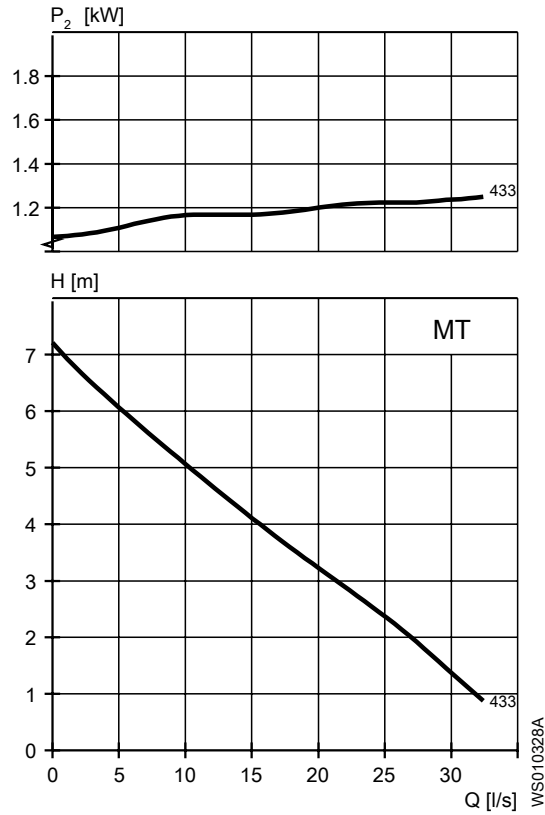

Table 25: 230 V, 50 Hz, 1-phase

Rated power, kW	Rated power, hp	Curve/ Impeller No	Revolutions per minute, rpm	Rated Current, A	Start current, A	Power Factor, cos φ	Installation
1.3	1.7	433	1400	8.4	28	1	F,P,S

SH

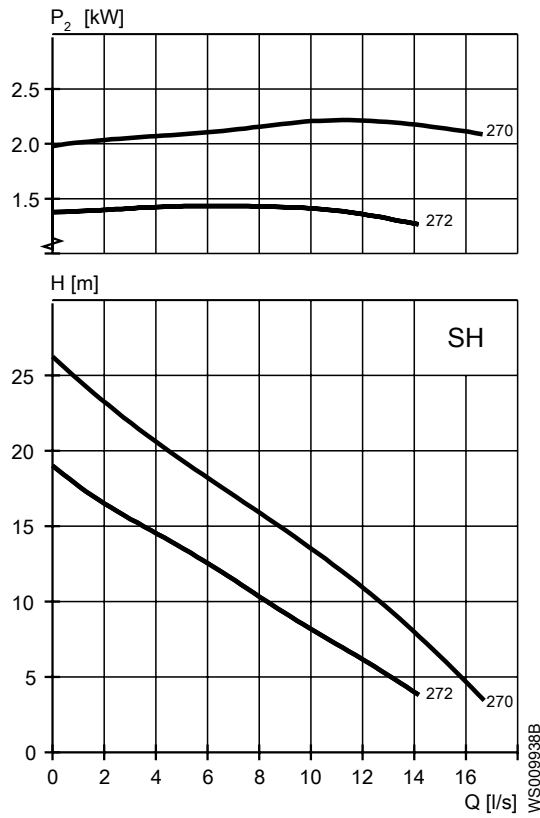

Table 26: 400 V, 50 Hz, 3-phase

Rated power, kW	Rated power, hp	Curve/ Impeller No	Revolutions per minute, rpm	Rated Current, A	Start current, A	Power Factor, $\cos \varphi$	Installation
2.4	3.2	270	2775	5.1	27	0.86	F,H,P,S
2.4	3.2	272	2775	5.1	27	0.86	F,H,P,S
1.7	2.3	272	2695	3.8	17	0.87	F,H,P,S

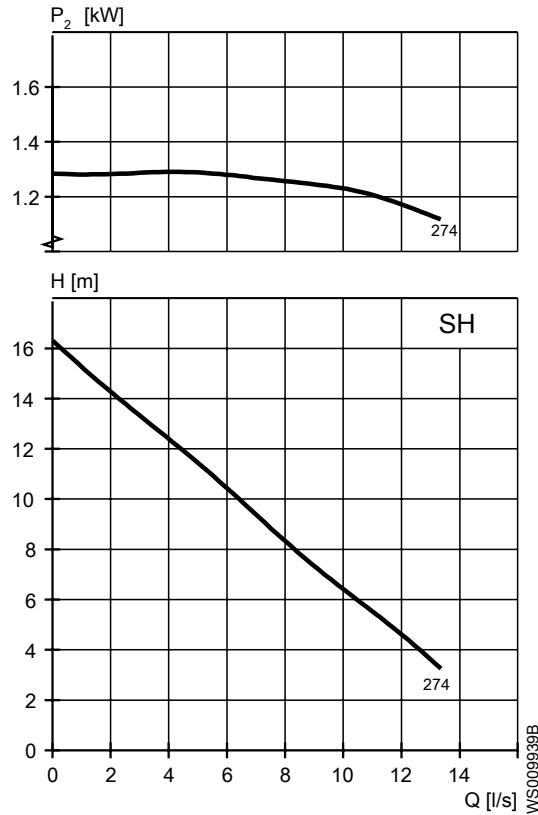

Table 27: 230 V, 50 Hz, 1-phase

Rated power, kW	Rated power, hp	Curve/ Impeller No	Revolutions per minute, rpm	Rated Current, A	Start current, A	Power Factor, $\cos \varphi$	Installation
1.5	2	274	2730	8.9	28	0.99	F,H,P,S

4.4 Motor rating and performance curves 3069.760

These are examples of motor rating and curves. For more information, please contact your local sales and service representative.

Star-delta starting current is 1/3 of Direct on-line starting current.

MT

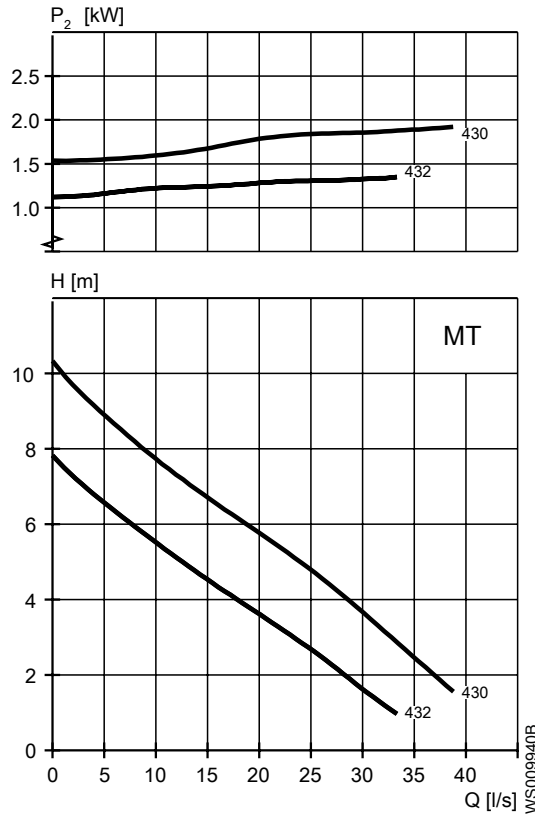

Table 28: 400 V, 50 Hz, 3-phase

Rated power, kW	Rated power, hp	Curve/ Impeller No	Revolutions per minute, rpm	Rated Current, A	Start current, A	Power Factor, cos φ	Installation
2	2.7	430	1360	5.0	20	0.83	F,P,S
2	2.7	432	1360	5.0	20	0.83	F,P,S
1.5	2	432	1370	4.4	16	0.76	F,P,S

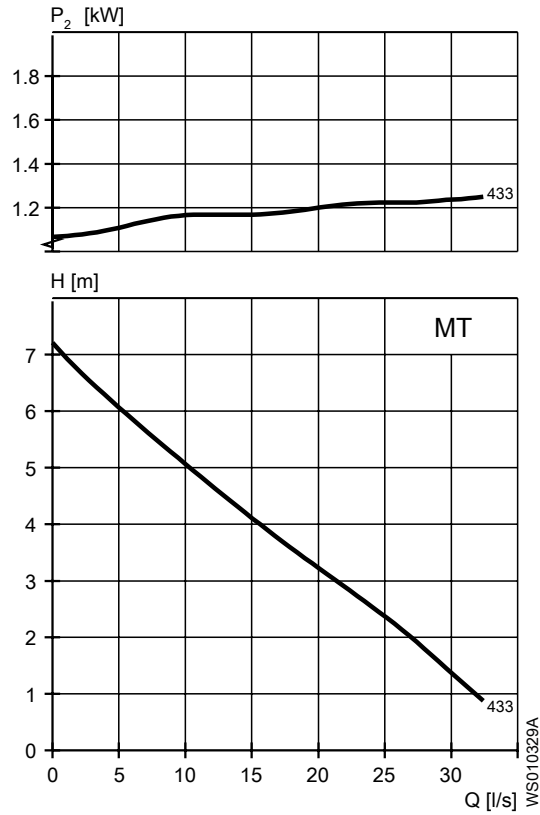

Table 29: 230 V, 50 Hz, 1-phase

Rated power, kW	Rated power, hp	Curve/ Impeller No	Revolutions per minute, rpm	Rated Current, A	Start current, A	Power Factor, cos φ	Installation
1.3	1.7	433	1400	8.4	28	1	F,P,S

SH

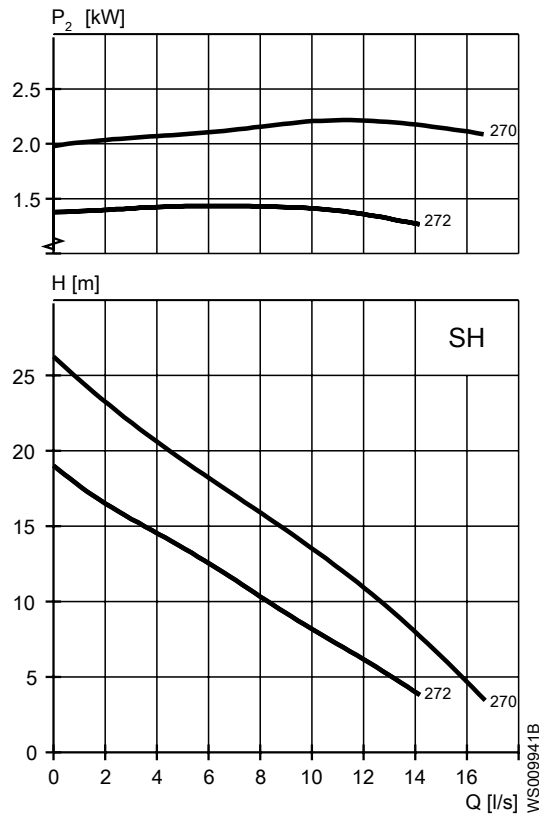

Table 30: 400 V, 50 Hz, 3-phase

Rated power, kW	Rated power, hp	Curve/ Impeller No	Revolutions per minute, rpm	Rated Current, A	Start current, A	Power Factor, cos φ	Installation
2.4	3.2	270	2775	5.1	27	0.86	F,H,P,S
2.4	3.2	272	2775	5.1	27	0.86	F,H,P,S
1.7	2.3	272	2695	3.8	17	0.87	F,H,P,S

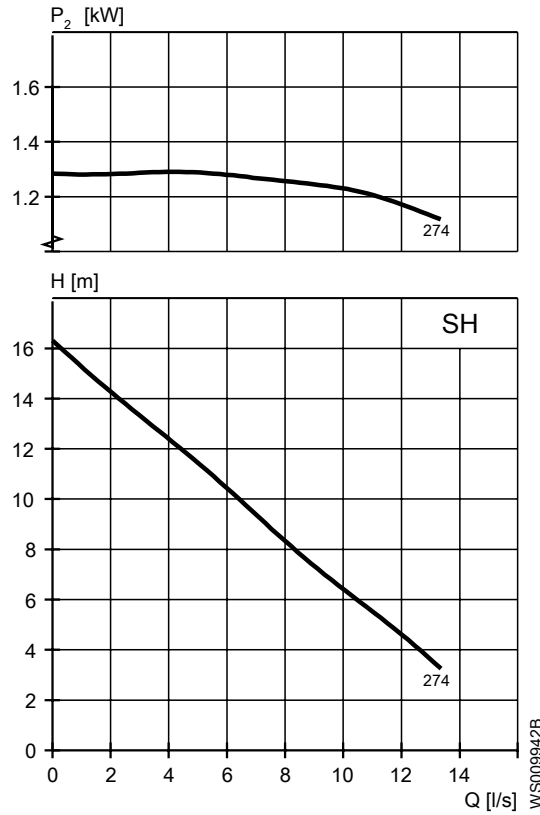

Table 31: 230 V, 50 Hz, 1-phase

Rated power, kW	Rated power, hp	Curve/ Impeller No	Revolutions per minute, rpm	Rated Current, A	Start current, A	Power Factor, cos φ	Installation
1.5	2	274	2730	8.9	28	0.99	F,H,P,S